

Semco® 1088 CE mixer

Operating instructions & troubleshooting guide



Table of Contents

1 - Requirements & ratings	2
2 - Machine description	3
3 - Safety instructions	4
4 - Safety features	5
5 - Set-Up	5
6 - Lay-out	6
7 - Operation	7-8
8 - Maintenance	9
9 - Preventative Maintenance	10-14
10 - Troubleshooting	15-20
11 - Spare Parts	21-23
12 - Calibration Procedure	24-28
13 - Appendix	29
14 - Schematic	30

Notice

This document is based on information available at the time of publication. While PPG, has made every effort to provide current and accurate information, this manual will cover all contingencies regarding installation, startup, operation, and maintenance based on data collected during factory acceptance testing and production simulation runs by PPG.

PPG assumes no responsibility for third-party or original equipment manufacturer (OEM) documentation used for this publication or included as supplemental information that is to be used as an internally controlled document.

This publication may not be reproduced by any means or distributed, in whole or in part, without the express written consent of PPG.

1. Requirements & ratings

- 1.1 SEMCO® Model 1088 CE Mixer is not to be used in explosive environments.
- 1.2  **Compressed air, no oil, moisture, or dust particles.**
- 1.3 Pressure min/max: 85 psi (5.9 bar) – 95 psi (6.6 bar). It is recommended that a regulator/filter be used at the machine location to ensure clean, dry air is supplied.
- 1.4 Air rate required: Min. 3 CFM
- 1.5 Length x width: 380 mm x 300 mm
- 1.6 Height min/max: 775/975 mm
- 1.7 Max. working stroke: 250 mm
- 1.8 Max. motor speed: approx. 150 rpm
- 1.9 Max. torque at driver: 29 Nm
- 1.10 Cartridge outer diameter: 43 mm
- 1.11 Recommended set-up height: normal workbench height
- 1.12 Weight: approx. (35 kg) – 75 lb

2. Description



The **Semco 1088CE Mixer** was developed for mixing of two-component cartridges holding 2.5 oz., 6 oz. and 8 oz. cartridges with 6" or 8" dasher rods.

The cartridges are ready for use directly after the mixing operation with *Semco 1088CE* mixer. The mixer ensures that the result of the mixture is uniform. During operation, the mixer injects the accelerator and strokes up and down so the components are evenly distributed in the cartridge. Rotation of the dasher rod, including the dasher, is affected by an air-operated motor.

The cartridge is inserted into an easy-to-operate slide plate assembly, and it is fixed securely by the cap assembly during the mixing operation. The cylinder in the cap assembly ensures that uniform pressure is exerted on the plunger during the mixing process, preventing any air from entering the cartridge during mixing.

By utilizing the *Semkit* package ruler on the left hand side of the *Semco 1088 CE* mixer, operators are able to identify what size cartridge and dasher rod length they have. With this information, the machine can be adjusted to the correct setting utilizing the *Semkit* configuration switch on the right hand side of the machine. The stroke motion is adjusted automatically to the cartridge size and fill level. Any differences in fill level, and/or tolerances between cartridges are detected and adjusted automatically by the *Semco 1088 CE* Mixer. Manual adjustment of the mixing stroke or pre-selection of the mixing time is not necessary. The duration of the mixing operation is determined by the number of strokes performed.

The *Semco 1088 CE* mixer can be used with a high degree of flexibility for various products. Its easy operation minimizes any operating errors. Together with the automatic stroke adjustment and automatic mixing time, the mixer contributes towards a consistently high quality mixing results. Its high strength construction, dual-guided stroke, reliability, and fully pneumatic control system enable the *Semco 1088 CE* mixer to have long intervals between maintenance and a long service life.

3. Safety instructions

- 3.1 Before operating mixer, read manual and follow all safety instructions.
- 3.2 General laws and regulations concerning safety and accident prevention must also be used when operating any machinery.
- 3.3 Only trained and authorized personnel shall operate and service this machine.
- 3.4 Never operate machine without safety guards in place.
- 3.5 To maintain the warranty of the machine, an external air filter and trap is required.
- 3.6 Wear approved industrial safety glasses and gloves.
- 3.7 Do not wear long hair, rings, watches, jewelry, or other loose items that could become caught in moving parts.
- 3.8 Keep all parts of your body away from moving parts. (belts, gears, etc.)
- 3.9 Do not attempt to bypass safety measures by placing hands, arms, legs, or any other body parts around or through the safety enclosure when safety devices are activated closed.
- 3.10 Use proper point of operation safeguarding.
- 3.11 Prior to servicing the machine, isolate all hazardous energy from the machine (electrical power, compressed air, etc.) also perform standard lockout/tag-out procedure.
- 3.12 Prior to performing service on commercial items, refer to the appropriate commercial item maintenance instruction sheet.
- 3.13 Do not trigger safety devices to regularly stop the machine. The safety devices are not intended to be used as the stop button.
- 3.14 Take special caution when opening the machine. The machine may not stop immediately when a safety device is triggered.
- 3.15 If an emergency arises and the machine must be stopped immediately, press the stop button located on the front of the machine.

4. Safety features

- 4.1 There are two primary safety features on this machine: machine safety guard door and stop push button.
- 4.2 The guard door is intended to prevent entry into the machine operating area while the machine is in operation. The mixer may not stop immediately when door is opened. Therefore caution must be taken before opening up the machine.
- 4.3 The stop button is located on the front of the machine. This button is to be used when an emergency arises and the machine needs to be stopped immediately.

5. Set-up

- 5.1 Make sure the mixer is placed on a firm level surface to withstand the weight of the machine. Check the working surface area and operation area.
- 5.2 Prior to use, verify mixer is in good and safe operational condition. Do not operate mixer if safety guards, operating parts, or components are damaged or missing.
- 5.3 Never operate mixer without a cartridge.
- 5.4 Never release a cartridge when the mixer is in operation.
- 5.5 Always place cartridge pusher assembly onto its holder when mixer is not in use or between cartridge cycles.
- 5.6  **When mixing dangerous or hazardous contents, please follow the safety precautions for handling and processing the product specified by the manufacturer or supplier.**
- 5.7 If necessary, the *Semco* 1088 CE mixer can be mounted to a flat surface using bolts and mounting holes on the base plate.
- 5.8 NOTE: After a long period of storage or initial use, the compressed air motor may not start immediately when the start button is pressed. In this case, the spindle made have to be manually turned several revolutions in a counter-clockwise direction. Afterwards, press start button to begin mixing.

6. Lay-out

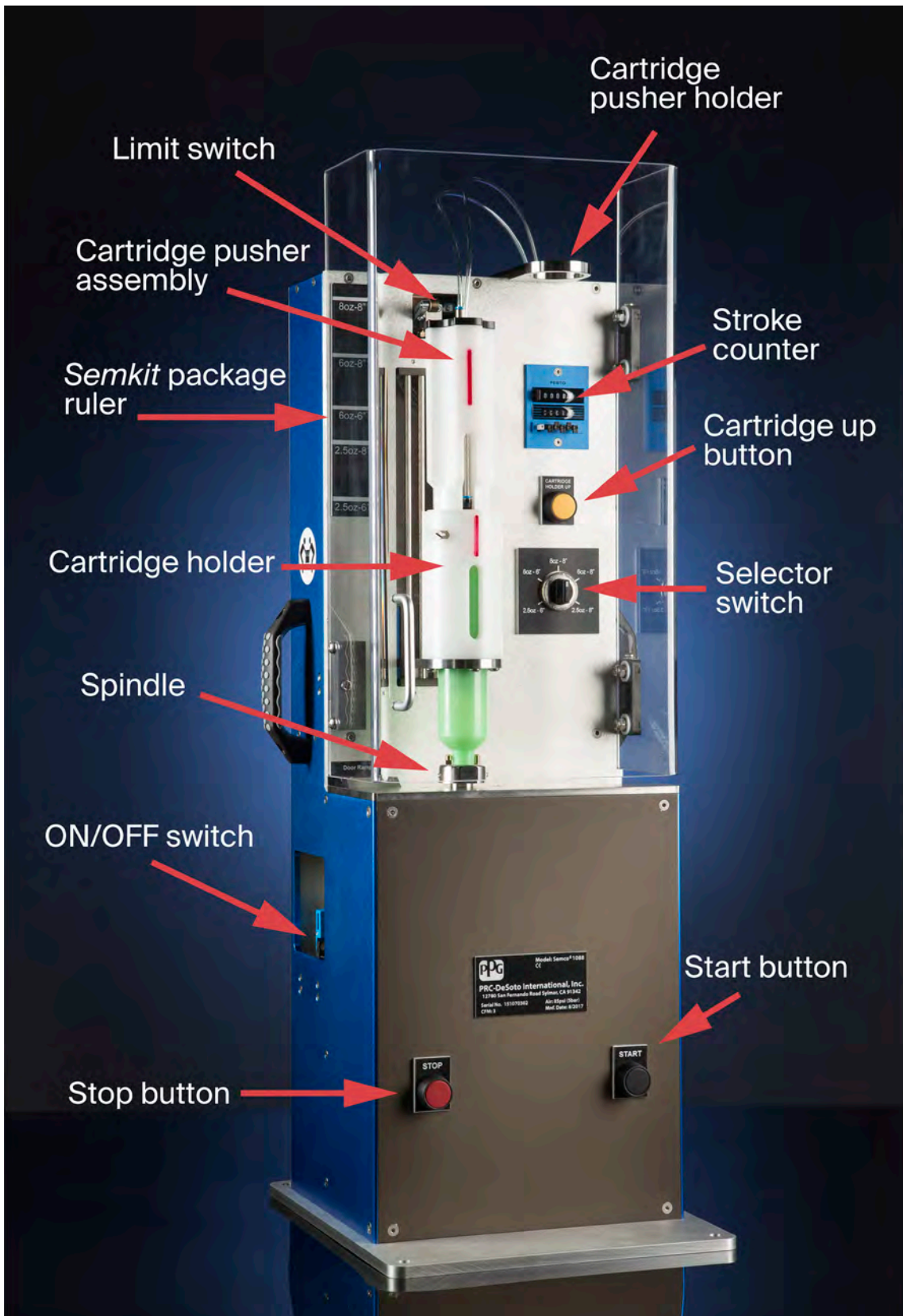

Version uploaded 05/11/2019

7. Operation

- 7.1 Open safety guard door.
- 7.2 If machine is holding a *Semkit* cartridge from previous cycle. Twist the cartridge pusher assembly clockwise to release and place into the cartridge pusher holder on the top of the machine. Release the dasher rod from the spindle drive pins and move the cartridge upwards, lift up, and remove *Semkit* from the cartridge holder.
- 7.3 New cartridge - Adjust to size. Use the *Semkit* package ruler to determine cartridge size and rod length. *Semco* sizes: 2.5 oz.-6" rod, 6 oz.-6" rod, 2.5 oz.-8" rod, 6 oz.-8" rod & 8 oz.-8" rod are supported. To determine the correct size, fully extend the dasher rod on the *Semkit* package all the way to the top of the cartridge and measure the length against the *Semkit* package ruler. Use *Semkit* configuration switch to select the configuration of dasher rod and cartridge. The machine will automatically adjust to the selected configuration. See Appendix 1 for *Semkit* package diagram (barrier and injection style).
- 7.4  For barrier style *Semkit* packages, remove tape surrounding cartridge and break the dasher free (loosen barrier) before loading into mixer.
- 7.5 Load the *Semkit* into the cartridge holder and take the cartridge pusher assembly and place into the open end of the *Semkit* cartridge. Press the cartridge holder up button while pushing down on the cartridge pusher assembly. Twist cartridge pusher firmly counter-clockwise to lock the pins in place. The red (or black) indicator lines should be aligned to verify correct orientation.
- 7.6 Check the toggle switch (roller valve) top of the machine to make sure it's not depressed or jammed in any way by the two flags on the rear of the cartridge pusher assembly.

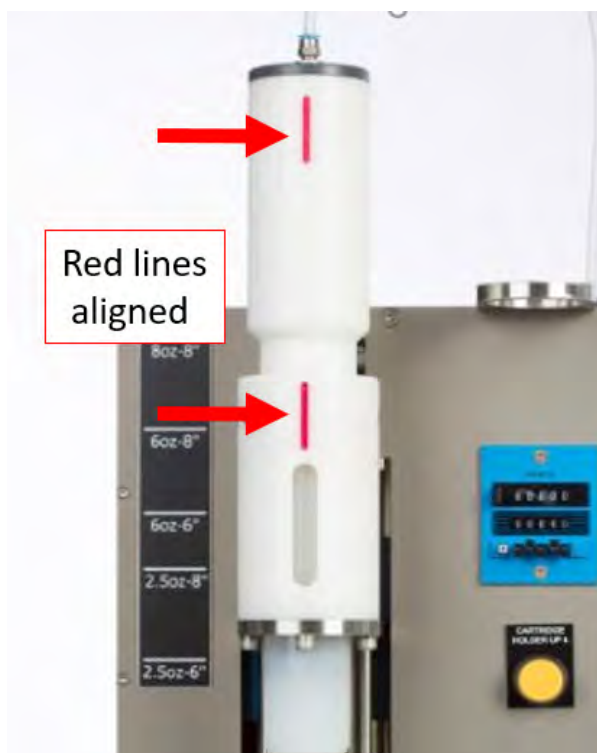
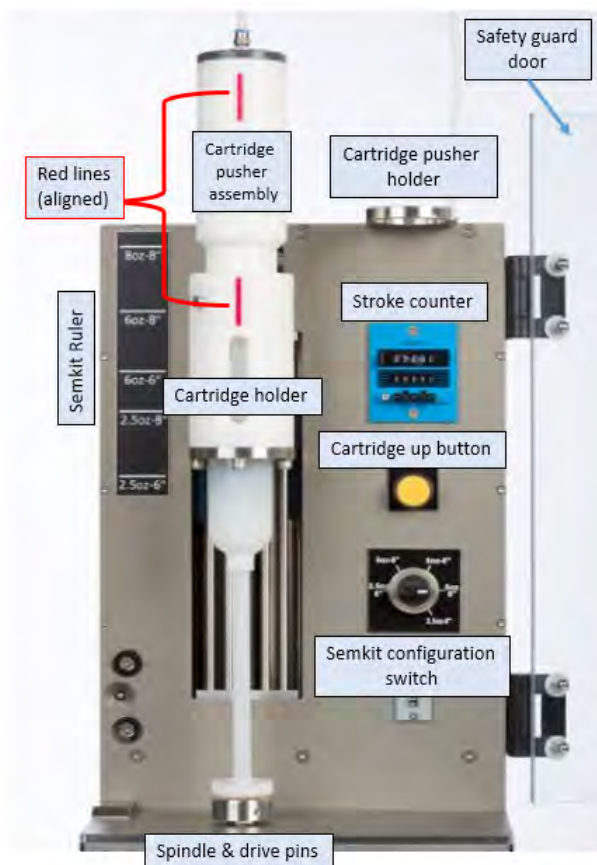

7. Operation (cont.)

- 7.7 Align the dasher rod drive holes on to the spindle drive pins.
Twisting the spindle counter-clockwise will help engage the pins to the dasher rod prior to start.
- 7.8 Read the bag of the *Semkit* package and identify how many strokes are required (this will be referenced under 'Hand-mix' but this process is acceptable for mixing on the Semkit 1088CE mixer). Set the double-stroke preset counter.
- 7.9 Presetting Counter. Hold the white button down on the counter to change the stroke count. On cycle counter select desired number of up/down strokes. Lower display is for preset number and the upper is the actual number strokes completed.

If the machine door is opened during operation or if the stop button is pressed, the stroke count will return to zero. The machine will not restart from where it was interrupted.

- 7.10  Before starting each mixing cycle, make sure the cartridge is clamped into the cartridge holder and the dasher rod is inserted to the drive pins.
- 7.11 Close safety door.
- 7.12 Press the "Start" push button (black) to begin operation.
- 7.13 Mixing will perform entire sequence without operator's intervention. Wait until machine switches off automatically.
- 7.14 Once the mixer stops cycling, the operation is over.
- 7.15 Removing Cartridge. Simply follow steps 7.1 & 7.2

When the stop button is pressed or door is opened during operation, the system will reset the counter.

Automatic Catalyst Injection

The *Semco* 1088 CE mixer features an injection rod that automatically travels through the dasher rod during the mixing cycle. The injection rod is designed to completely dispense all catalyst into the cartridge during mixing. No pre-injection using the ram rod is required.

Keep the injection rod clean by following instructions in the maintenance section.

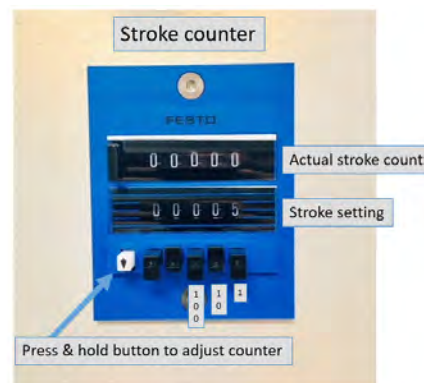
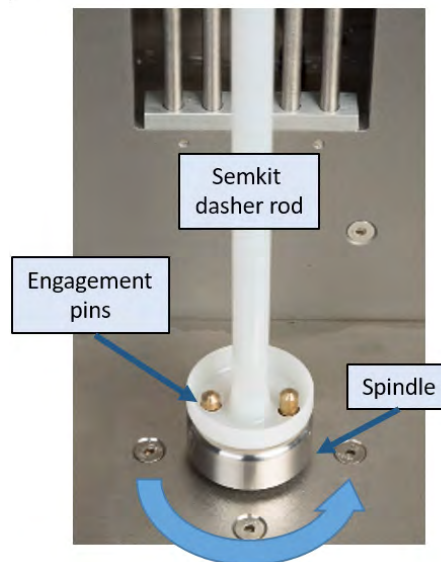

8. Maintenance

⚠ Before carrying out any maintenance work, repairs, or cleaning, release the air from the mixer by opening the main valve. This is done by turning the on/off valve to the off position. Also, disconnect mixer from the compressed air supply.

Some preventative maintenance activities will require the removal of the rear or front panels. Listed below are instructions.

Removing the rear panel –

The rear panel is attached by 10 Allen wrench bolts.

1. Using Allen wrench, remove all 10 bolts from the rear panel.
2. When maintenance work is completed, re-install the bolts.
3. Do not overtighten bolts.



Removing the front panel –

The front panel is attached by 4 Allen Wrench bolts.

1. Remove the four screws (McMaster-Carr 92125A210) using a 3mm Metric Allen wrench on the front lower panel of the mixer.
2. Remove the lever on the start & stop switches (on the inside panel) from the lock position to unlock which will release the door panel from the switches.
3. Reattach the start and stop buttons to the door panel and lock them in place. Put door panel back on and screw in the four screws in the corners of the front panel back on the machine. *Do not overtighten.*

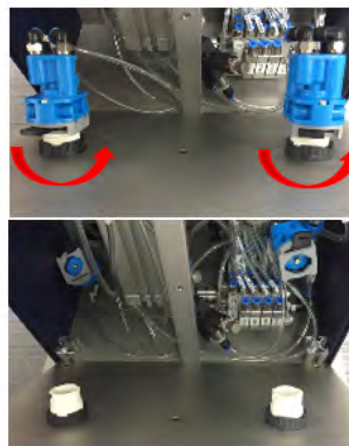

Switches after being released from the panel

Version uploaded 05/11/2019

9. Preventative maintenance

Daily

1. Complete a quick visual inspection of the unit to ensure surfaces are clear from dust, sealants/adhesives, other liquids, etc. Use a clean cloth to clear machine surfaces. If debris remain, use a solvent approved by your location and clean cloth to clear surfaces and use solvent sparingly.
 - In particular, check the spindle to ensure the item is clean and clear of any residual sealant/adhesive. If not clean, apply isopropyl alcohol (IPA) to a clean cloth to remove sealant/adhesive.

⚠ Harsh solvents like acetone, paint thinners, isocyanate, and MEK should not be used.

2. Inspect injection rod – With machine in off position, pull up the injection rod and inspect surface for contamination. Clean with cloth as needed.



Pull injection up

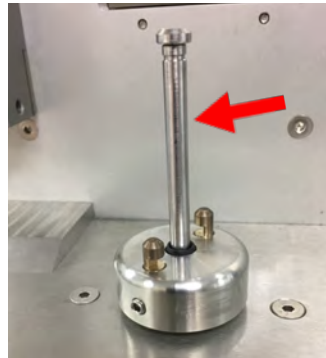

Wipe rod with cloth

3. Ensure start/stop buttons work – If not, check the Trouble shooting section 10.
4. Inspect hose that connects to the cap assembly and assure there is no damage, such as a kinked hose, which will affect the performance of the machine.
5. Listen for air leaks when the mixer is turned off. If an air leak is heard, contact your maintenance department or refer to the Troubleshooting section 10.
6. The filter /regulator should be checked on at least a weekly basis, more often if usage is heavy. This will ensure the longevity of the mixer.
7. Check cartridge pusher pins for tightness. Turn clockwise using flat head screw driver.



Cartridge pins on the cartridge pusher

Version uploaded 05/11/2019

9. Preventative maintenance

⚠ Turn OFF/ON Switch to OFF and disconnect compressed air supply prior to opening any mixer panels. Work should be done in non-hazardous area.

Quarterly (monthly for heavy usage)

Main guide shafts - The main guide shafts and bushings should be inspected for damage and clean from sealant material. This will reduce the amount of the dust/grease that may accrue on the surface and help to ensure smooth operation of the unit.

1. Remove rear panel.
2. Clean shafts and bushings with dry cloth as needed. If the shafts are coated with sealant or other contaminant, use IPA with cloth to clean surfaces.
3. Reinstall rear panel and bolts.
4. Do not overtighten bolts.



Lubricate air motor - The Semco 1088 CE mixer is designed with a motor that does not require constant lubrication. However, with heavy usage it would be prudent to lubricate the motor on a monthly basis.

1. Remove front panel.
2. Identify the hose going into the air motor labeled as 1a and depress the Push-In fitting to release the hose.
3. Once the hose has been released from the air motor, insert 4-5 drops of standard 3-in-1 oil into the hose and re-insert the hose into the air motor.
4. Re-install front panel.



9. Preventative maintenance

⚠ Turn OFF/ON Switch to OFF and disconnect compressed air supply prior to opening any mixer panels. Work should be done in non-hazardous area.

Quarterly (monthly for heavy usage)

Inspect air motor muffler

1. Remove front panel.
2. Remove muffler assembly on bottom of motor using 17mm Wrench and turning counter-clockwise.
3. Note that plastic ring is on top of the metal muffler. Using cloth with IPA wipe down the inner shaft and inside the metal muffler. Inspect for contamination.
4. Re-install front panel.

⚠ Do not turn set screw at the end of the shaft, this will affect the rpm of the mixer. After cleaning, re-calibration of the spindle rpm may be required.



Inspect under spindle and clean

Remove engagement spindle

1. Use thin 19 mm wrench to hold the rotating bearing underneath the engagement spindle in place.
2. Hold on to spindle with an adjustable wrench as shown. (If there are no flat areas on the spindle, use screwdriver between the engagement pins to loosen.)
3. Turn adjustable wrench counter. clockwise to loosen and remove.

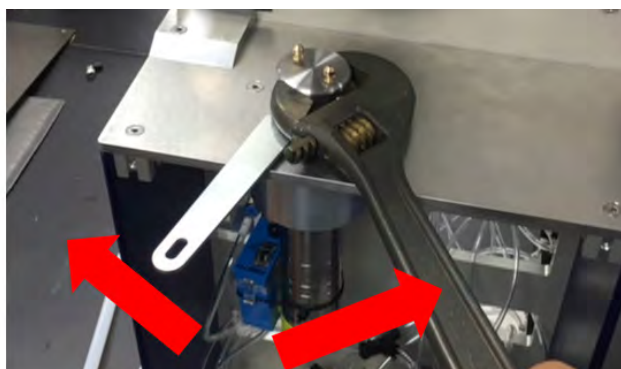

Wipe area with clean cloth. IPA solvent is OK.

9. Preventative maintenance

Turn OFF/ON Switch to OFF and disconnect compressed air supply prior to opening any mixer panels. Work should be done in non-hazardous area.

Quarterly (monthly for heavy usage)

Inspect air motor belt – the timing belt drives the rotary bearing shaft, turning the dasher rod during the mixing cycle.

1. Remove front panel.
2. Inspect physical condition of the timing belt, looking for any frayed threads or other signs of wear.
3. The belt should also have minor flexibility when pressed on. If too loose or tight, the belt could be damaged.



Change air motor belt

1. Remove front panel, rear panel.
2. Remove spindle.
3. Remove 4 M5 bolts around the spindle.
4. Loosen the four bolts on the rear of the mixer holding the air motor.
5. Slide the air motor toward the injection assembly.
6. The rotary bearing shaft will slide up and allow for the old belt to come out and the new belt to be placed in.

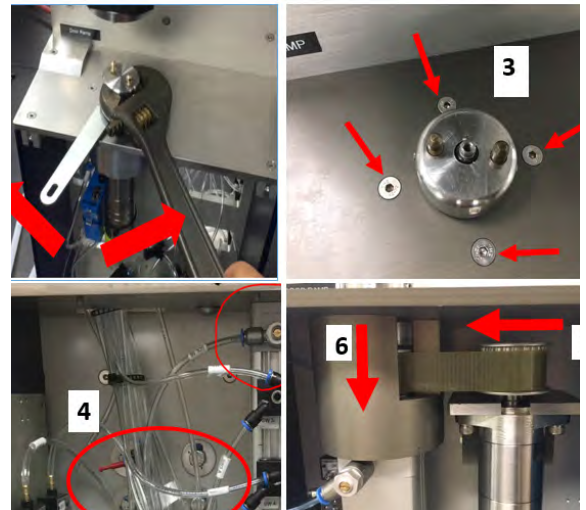

9. Preventative maintenance

Annual

In addition to the monthly PM activities listed above, the *Semco* 1088 CE mixer is calibrated to function at the optimal rate to completely mix all sizes of *Semkit* packages. The mixer's timed functions should be checked at least on an annual basis to ensure consistent operation. The factory settings are as follows:

- Spindle rpm (the rotations of the dasher rod per minute): 140 +/- 5
- Stroke cycles (up and down cycles, using water filled 6 oz.- 8" cartridge kit): 20 +/- 1 cycles/min.
- Toggle switch: 30 +/- 5 degrees from horizontal
- Dome/Plunger side timer settings: 0.25s (1/2 way through white indicator)
- Injection brake timer: 2s

Please refer to the Calibration section 12 for verifying current settings or making adjustments, if needed

10. Troubleshooting

Issue: After closing the door and pressing 'Start' the mixer does not start

1. Check the air line and ensure it is 'on' and hooked up to the mixer properly.
2. Check the air supply switch and ensure it is in the 'on' position.

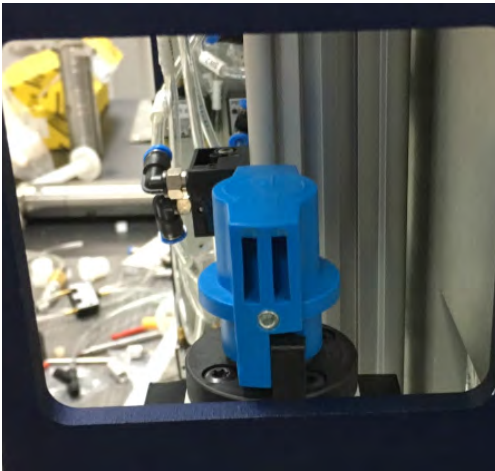

Air supply switch in the 'Off' position

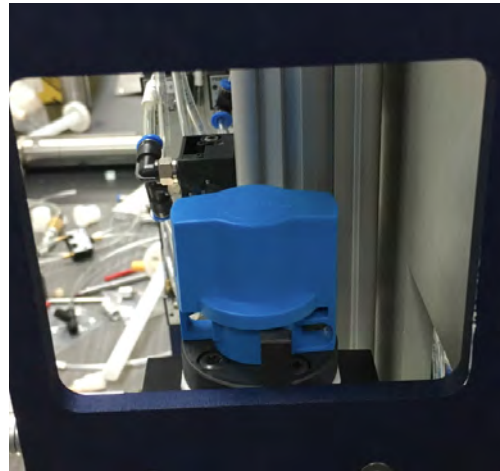

Air supply switch in the 'On' position

3. Ensure that the safety door pin is properly engaging the safety switch when the front door is closed. The switch is circled below:

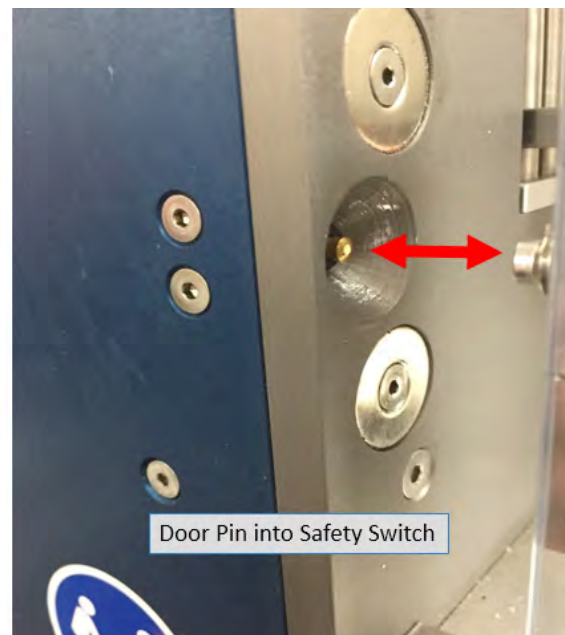

10. Troubleshooting (cont.)

4. Ensure cycle counter dial is set to a number GREATER than '0'. To set, press down white button and then press in corresponding back buttons.
5. If none of these actions resolve the issue, please contact your local application support center (ASC) for technical support.

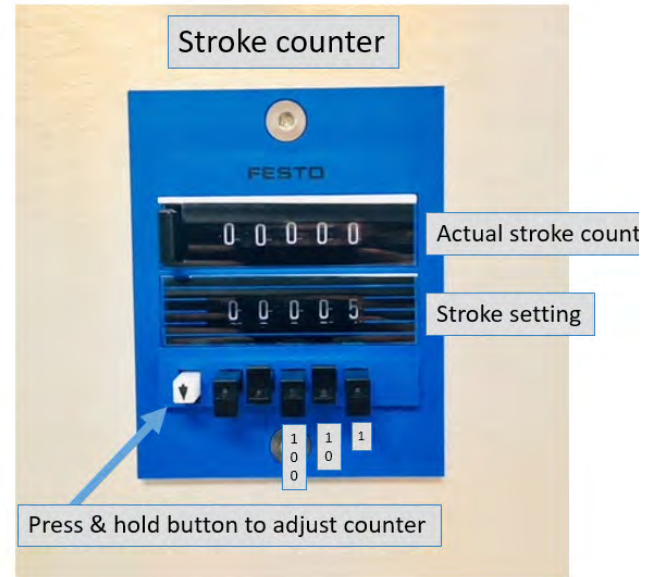

Stroke counter is set to 5 in this example

Issue: Machine starts operating, but stalls in the 'UP' position.

1. Check to make sure you have the proper configuration of the *Semkit* package you are trying to mix. Utilize the *Semkit* package ruler on the left hand side of the machine by pulling the dasher rod of the *Semkit* all the way to the top of the cartridge and placing on the door ramp to identify the proper type of *Semkit* package. Then, turn the *Semkit* package configuration switch accordingly.

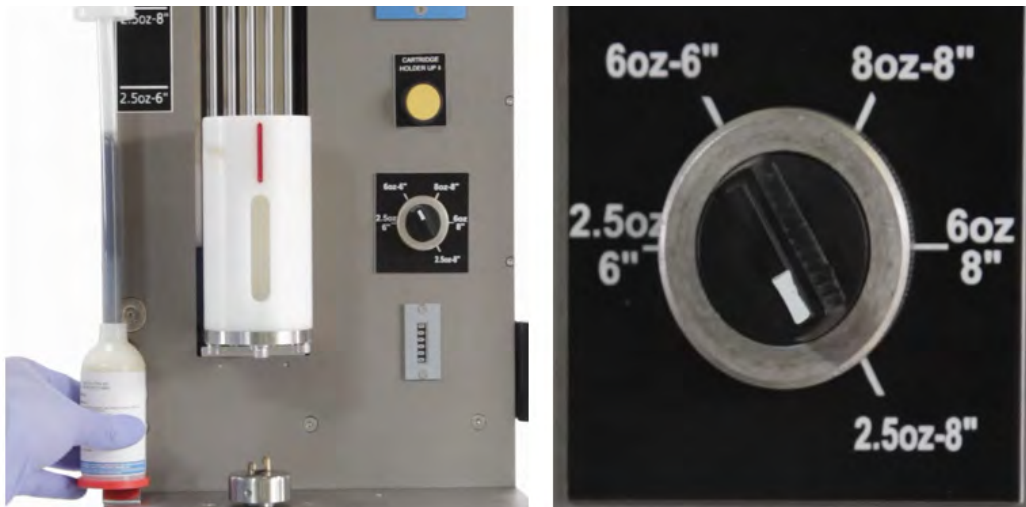

Semkit shown about is 2.5 oz. - 8"

2. Ensure that the safety door pin is properly engaging the safety switch when the front door is closed.

10. Troubleshooting (cont.)

3. Cartridge dasher rod (on *Semkit* package) may be over threaded. If the dasher rod can't be easily unthreaded from the cartridge, this may be the problem. Continue with another cartridge and restart mixer.
4. Sensor locations on the main cylinder may have moved or sensor has failed. See Calibration procedure section 12.
5. If none of these actions resolve the issue, please contact your local application support center (ASC) for technical support.

Issue: Machine starts operating, but stalls in the 'DOWN' position.

1. Check to make sure you have the proper configuration of the *Semkit* package you are trying to mix. Utilize the *Semkit* package ruler on the left hand side of the machine by pulling the dasher rod of the *Semkit* all the way to the top of the cartridge and placing on the door ramp to identify the proper type of *Semkit* package. Then, turn the *Semkit* package configuration switch accordingly.
2. Ensure the cap assembly has been put into the cartridge holder properly. The cap assembly is in the correct position when you see the red line on the cap assembly in line with the red line on the cartridge holder (pictured below). If you do not see the red/black line, then the cap assembly is in the incorrect position.



Cap Assembly in correct position



Cap Assembly in **WRONG** position

Version uploaded 05/11/2019

10. Troubleshooting (cont.)

Issue: Machine starts operating, but stalls in the 'DOWN' position.

1. Verify the cartridge pusher is installed completely into the cartridge holder. If the pusher is not fully twisted into the locked/closed position, the toggle arms will not make contact with the toggle sensor. See pictures below:

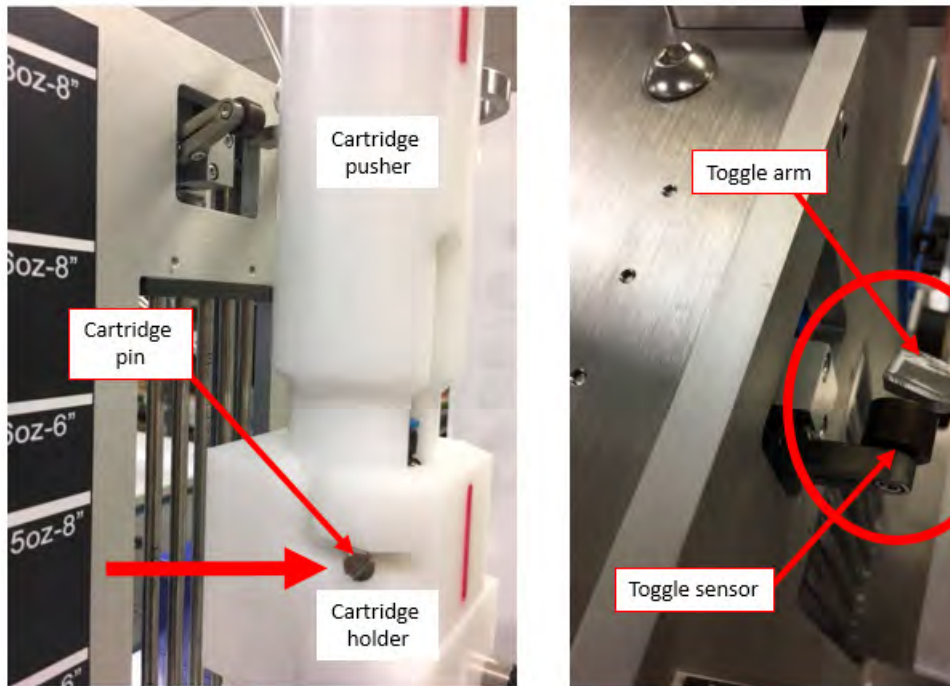

Cartridge pusher is not turned completely into cartridge holder (left). The pin needs to make contact to the edge of the slot. The toggle arm on the cartridge pusher does not make contact with the toggle sensor (right) while in the down stroke cycle.

2. Toggle sensor is not loose or out of position. It should be 30 degrees from horizontal position. If the toggle arm is loose or has fallen to a more horizontal position, use 2.5 mm Allen wrench to re-position and tighten the bolt. Adjusting the sensor higher will reduce chance for stalling, but *may* mix the plunger end of the cartridge less. (See Calibration-toggle switch in Section 11.)
3. Remove the cartridge pusher assembly and check for debris inside cartridge (behind plunger). This may be preventing the mixer from completing the down stroke properly.

10. Troubleshooting (cont.)

Issue: Material is not mixed properly on the plunger end.

1. Check to make sure you have the proper *Semkit* package configuration selected for the package you are trying to mix. Utilize the *Semkit* package ruler on the left hand side of the machine by pulling the dasher rod of the *Semkit* package all the way to the top of the cartridge and placing on the door ramp to identify the proper *Semkit* package. Then, turn the *Semkit* package configuration switch accordingly.

2. Review the cap assembly hose (McMaster-Carr 50315K68) and make sure it's not tangled, kinked, or otherwise damaged.



3. Review the flags on the back of the cap assembly and ensure they are not bent, broken, or otherwise damaged.



Position Flags



Toggle Sensor

4. Verify the toggle sensor is not loose or out of position. It should be 30 degrees from horizontal position; however, it should be 'engaging' when at the horizontal position. If the toggle arm is loose or has fallen to a more horizontal position, use 2.5 mm Allen wrench to re-position and tighten the bolt. Adjusting the sensor higher will reduce chance for stalling, but *may* mix the plunger end of the cartridge less.

10. Troubleshooting (cont.)

Issue: Material is not mixed properly on the dome side of cartridge

1. Check to make sure you have the proper *Semkit* package configuration selected for the *Semkit* you are trying to mix. Utilize the *Semkit* package ruler on the left hand side of the machine by pulling the dasher rod of the *Semkit* package all the way to the top of the cartridge and placing on the door ramp to identify the proper *Semkit* package type. Then, turn the *Semkit* package configuration switch accordingly.
2. Sensor locations on the main cylinder may be have moved or sensor has failed. See Calibration section 11.
3. If none of these actions resolve the issue, please contact your local application support center (ASC) for technical support.

Issue: No injection of catalyst or incomplete injection of catalyst

1. Check top of the spindle to make sure it is clear of debris which may be preventing the cylinder from injecting the catalyst.
2. Manually pull injection cylinder up and wipe any excess debris that may exist on the rod (compressed air must be disconnected). See Preventative maintenance section 9.1.



Issue: Mixing engagement spindle does not rotate when start button pushed or has a delayed start.

1. Verify air pressure supplied to the mixer is 85-95 psi.
2. Ensure that the safety door pin is properly engaging the safety switch when the front door is closed.
3. Manually turn the spindle 2-3 turns counter-clockwise.
4. Clean air motor muffler (See Preventative maintenance section 8).



Spindle does not turn

11. Spare parts (mixer front)

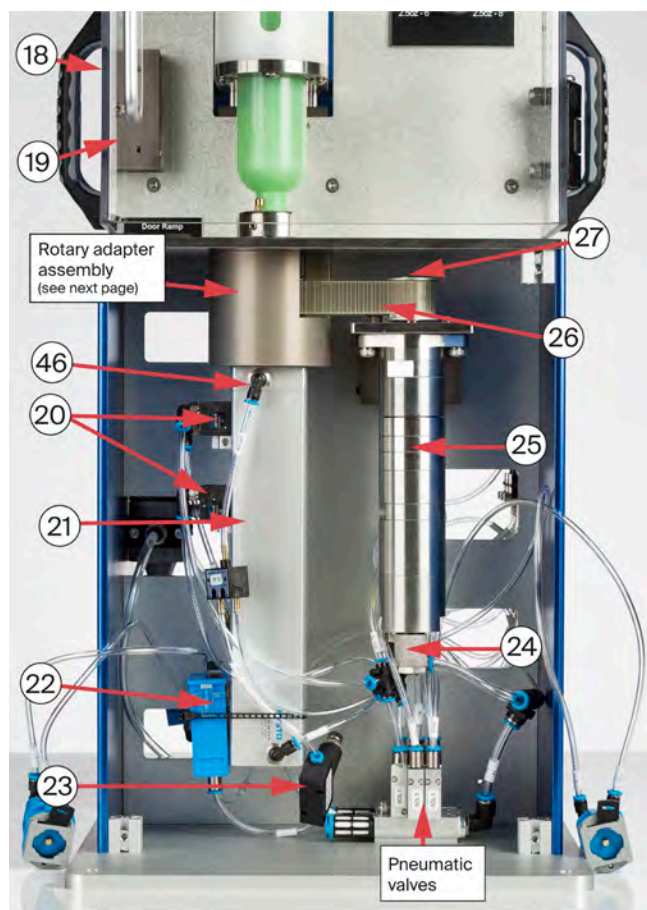
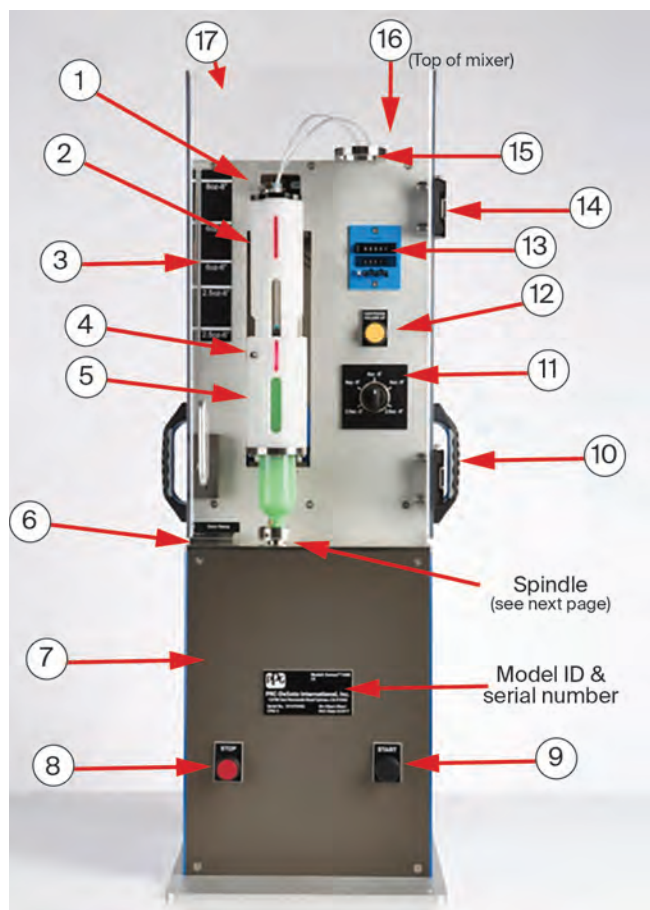

Item	Part number	Description
1	235200	Toggle switch lever
2	235201	Cartridge pusher assembly
3	Contact PPG	<i>Semkit</i> ruler
4	235202	Cartridge pusher pin
5	235203	Cartridge holder
6	Contact PPG	Door ramp
7	Contact PPG	Front door
8	235207	Stop button
9	235208	Start button
10	Contact PPG	Handle
11	235192	Selector switch kit
12	235205	Cartridge up button
13	235183	Stroke counter
14	235231	Front clear door hinges
15	Contact PPG	Cartridge pusher holder
16	235204	4 mm bulkhead fitting

Item	Part number	Description
17	235193 / 235229	Front clear door, handle only / front door assembly (with safety block)
18	Contact PPG	Door magnet
19	235230	Safety door block
20	235184	Proximity sensor
21	235212	Injection cylinder assembly
22	Contact PPG	Injection rod timer
23	Contact PPG	Injection rod pressure regulator
24	235213	Speed throttle control
25	235186	Air motor
26	235187	Timing belt
27	235214	Pulley-18
46	Call PPG	Flow control valve

Version uploaded 05/11/2019

11.1 Spare parts (assemblies)

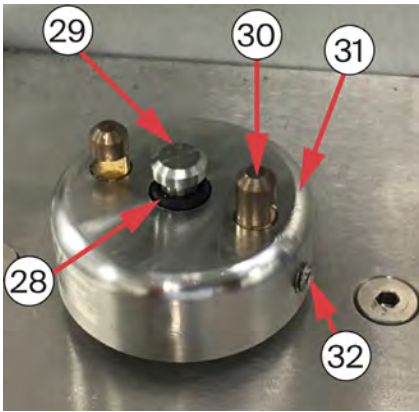

Item	Part number	Description	Source	Qty
28	235198	Injection rod seal (under spindle)	Semco	1
29	235233	Injection rod bolt (LH 4mm)	Semco	1
30	235189	Engagement pin	Semco	2
31	235199	Spindle	Semco	1
32	92785A332	10 - 32 set screw	McMaster-Carr	1

1088 Injection assembly

Item	Part number	Description	Source	Qty
1	235198	Oil seal	Semco	1
2	90967A235	Snap ring	McMaster-Carr	2
3	6680K380	Angular contact bearing	McMaster-Carr	2
4	Contact PPG	Pulley spacer (Delrin)	Semco	2
5	Contact PPG	Rotary bearing shaft	Semco	1
6	96717A198	Stainless steel machine key	McMaster-Carr	1
7	Contact PPG	24T Pulley (modified)	Semco	1
8	92125A216	SS flathead bolt	McMaster-Carr	4
9	ZBH-7	SS metric spacer	Festo	2
10	Contact PPG	Rotary adapter	Semco	1
11	92095A240	SS buttonhead bolt	McMaster-Carr	4
12	235215	Rotary bearing assembly	Semco	1

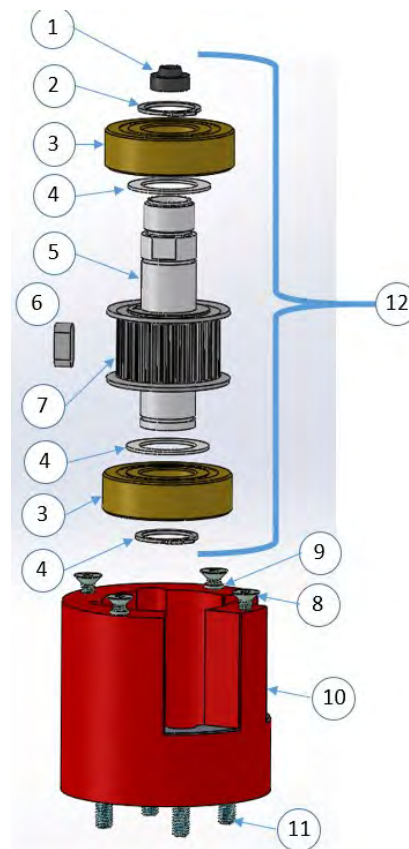

11.2 Spare parts (mixer rear)

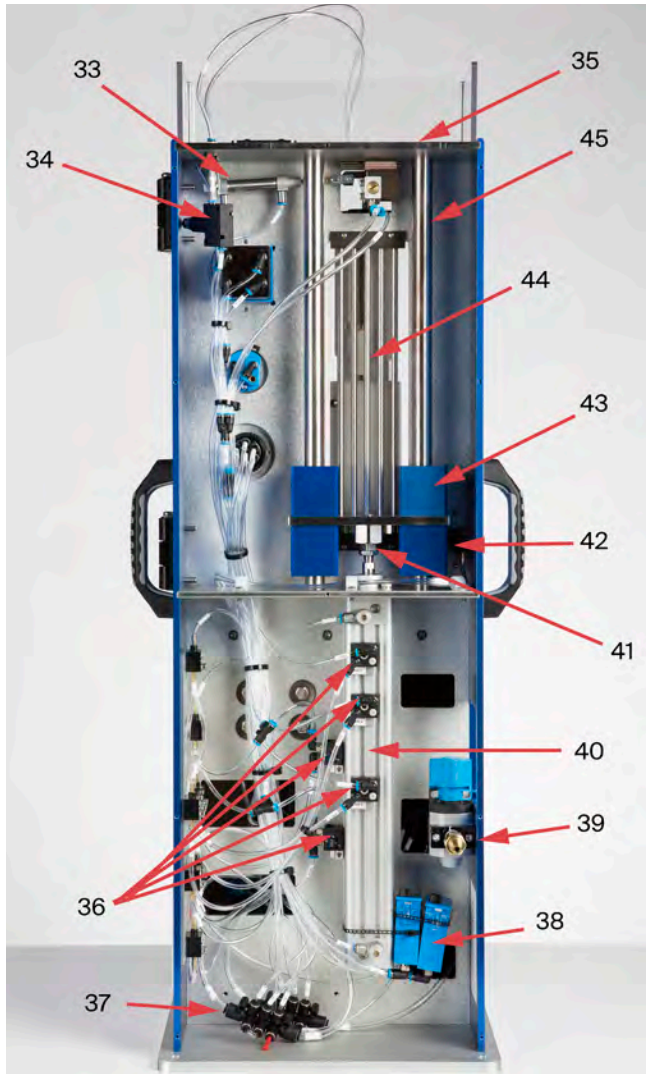

Rear view (no cover)



Rear view (with cover)

Item	Part number	Description
33	235206	Toggle cylinder
34	Contact PPG	Cartridge ram pressure regulator
35	92949A650	Shaft bolt (4) McMaster-Carr
36	235184	Proximity sensor
37	Contact PPG	Air manifold (2)
38	Contact PPG	Dome & plunger timer (2)
39	235217	OFF/ON air valve assembly
40	235216	Main air cylinder
41	Contact PPG	Floating joint

Item	Part number	Description
42	235210	Clear door safety switch
43	235211	Linear housing assembly (4)
44	Contact PPG	Safety cage (5)
45	235209	Shaft (2)
47	Contact PPG	Cartridge up pressure regulator

12. Calibration procedure

The *Semco* 1088CE mixer is calibrated to function at the optimal rate to completely mix all sizes of *Semkit* packages. The mixer's timed functions should be checked at least on an annual basis to ensure consistent operation. The factory settings are as follows:

5. Spindle rpm (the rotations of the dasher rod per minute): 140 +/- 5
6. Stroke cycles (up and down cycles, using water filled 6 oz.-8" cartridge kit): 20 +/- 1 cycles/min.
7. Toggle switch: 30 degrees from horizontal
8. Sensors and cartridge height settings – See pictures

Calibration – Spindle rpm

The slower or faster the rpm impacts the speed at which the base and catalyst are mixed. If the speed is too fast, the sealant may incur a higher than planned temperature, causing premature curing.

1. Use non-contact tachometer and place reflective stick on the spindle.
2. Close door, and activate mixer with NO *Semkit* package installed. The mixer will not cycle up/down; however, the spindle should spin at 140 +/- 5 rpms.
3. If mixer is outside that range, perform steps 4 through 6 below:
4. Open front panel.
5. The speed control is on the bottom of the muffler. Using a short/small flathead screwdriver, twist the screw until the 140 rpms is obtained.
6. Re-install front panel.

⚠ Use caution when activating the machine with the front panel open. There are moving parts, including the timing belt.



12. Calibration procedure (cont.)

Calibration – Stroke Speed (20 +/-1 per minute)

Speed is set with 6 oz.-8" cartridge kit filled with water. Using another kit size will affect the stroke speed, i.e. 2.5 oz. will be faster, 8 oz. will be slower at the same setting. The slower or faster the stroke setting, the more or less mixing 'work' goes into the cartridge.

1. Install 6 oz.-8" cartridge kit on the mixer and activate machine.
2. Remove rear panel.
3. On lower portion of the mixer, the main cylinder moves the cartridge holder up/down.
4. The stroke speed is adjusted by opening/closing the flow valves at the top and bottom of the main air cylinder
5. Using small flathead screwdriver, turn both upper and lower flow valves equally to adjust stroke speed. Start with ½ turn, then measure. Measure speed with stopwatch.

Clockwise: Slower

Counter-clockwise: Faster
6. One complete up/down cycle is counted as 1 stroke.
7. When done, reinstall rear panel.

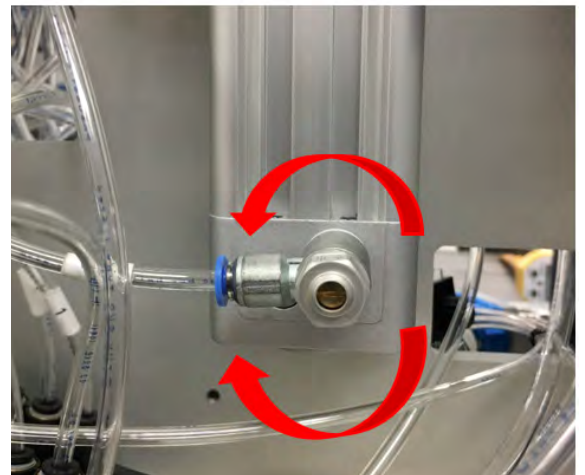
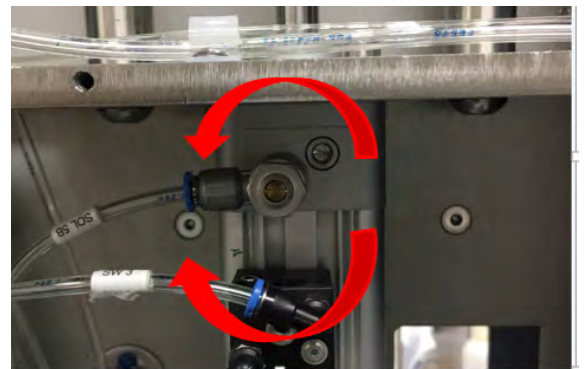
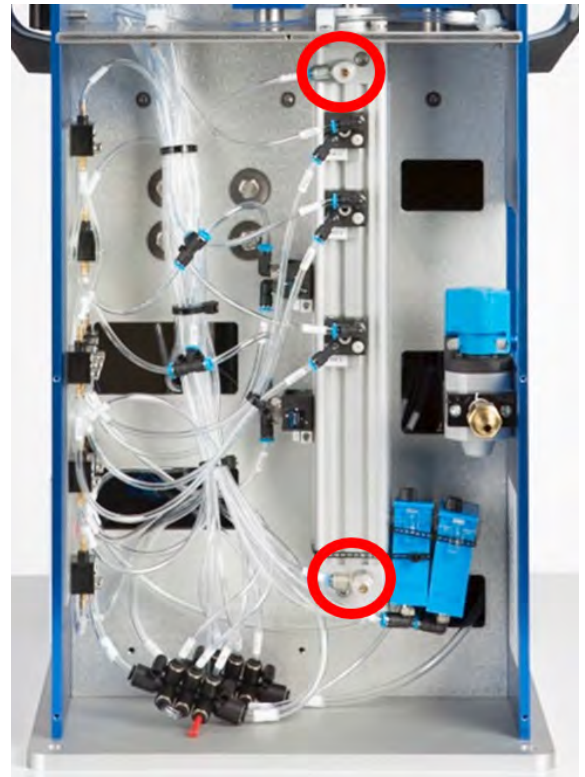

12. Calibration procedure (cont.)

Calibration – Semkit package sensor locations

The proximity sensors are pre-set locations instructing the mixer to switch direction at the dome of the cartridge. If the sensors are out of adjustment, the mixer may stall at the cartridge dome or not fully mix the dome area.

1. Remove rear panel.
2. On lower portion of the mixer, the main cylinder has 5 sensors mounted to the cylinder:

SW1 – 2.5 oz. - 6"	8 17/32"
SW2 – 6 oz. - 6"	5 7/16"
SW3 – 8 oz. - 8"	1 11/16"
SW4 – 6 oz. - 8" (20cc)	3 18/32"
SW5 – 2.5 oz. - 8"	6 21/32"

3. Check the sensor location. It is measured from the top of the cylinder to the top edge of the sensor. See red lines in picture.
4. **If sensors are greater than 1/32" from the locations listed above, proceed to step 5 below.**
5. Using 2.5 mm Allen wrench, loosen the sensor block bolt.
6. Move sensor up or down until proper measurement from top of cylinder is located.
7. Tighten sensor block bolt firmly.
8. When all checks/adjustments are completed, re-install Rear Panel.

When properly activated, the sensor “pin” should come out. If this does not happen during mixer, the sensor is out of position or needs replacement.

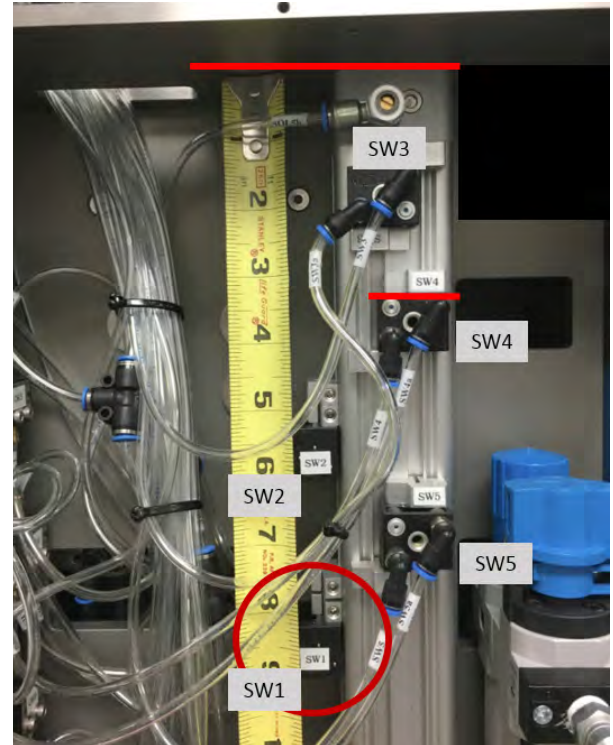

12. Calibration procedure (cont.)

Calibration – cartridge holder height adjustment

The floating joint between the air cylinder and cartridge holder is adjustable. It offsets all the proximity sensors and is held fixed by a locking bolt. Both the proximity sensors and 'knuckle' height should remain at preset locations.

1. Remove rear panel.
2. On upper portion of the mixer, the top of the cartridge holder plate (knuckle height) should be $2\frac{15}{32}$ " from the middle plate. Measure from bottom side of plate to middle plate.
3. To adjust the height, the locking bolt needs to be loosened. Twist locking bolt and adjustment knuckle bolt in opposite directions. Use 17 mm and 13 mm open end wrench.
4. Turn adjustment knuckle until desired height is achieved.
5. Tighten locking bolt while holding adjustment knuckle in place with another wrench.

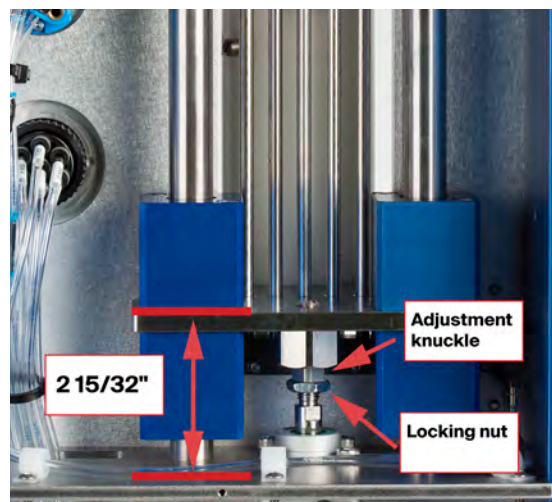

Calibration – toggle switch

The toggle switch is activated at the bottom of the down stroke. Its proper function allows mixing of the plunger side in the cartridge. Too low and the mixer may stall or cause excess movement of the plunger in the cartridge. Too high and there will be unmixed product near the plunger.

The toggle switch should be approximately 30 degrees from the horizontal position but the 'engagement point' is important. If adjustment is needed:

1. Use 2.5 mm Allen wrench to loosen the underside bolt.
2. Move to approximately 30 degree position, and re-tighten bolt.
3. Move the lever by lightly pressing down on the lever with your finger to feel a slight resistance to the lever motion downward. This is the position where the lever engages the internal valve.
4. If lever does not move, use flathead screwdriver to hold the sensor while moving the lever manually.

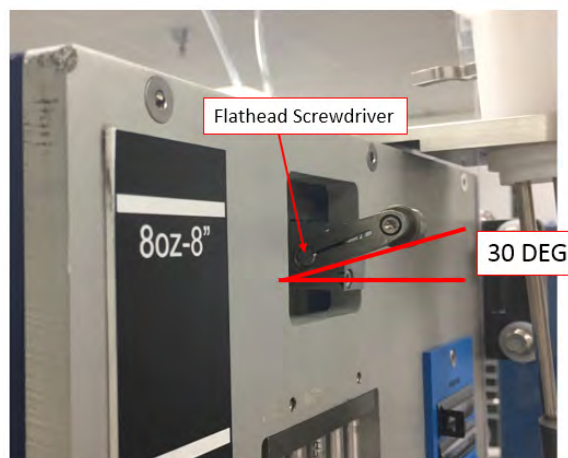

12. Calibration procedure (cont.)

Calibration - Injection rod brake system

1. Remove front panel.
2. Check distance from the top of the proximity sensor to the top of the injection cylinder.
3. The distances should be:
8" dasher rod sensor (top) - $1 \frac{3}{16}$ " (30.2 mm)
6" dasher rod sensor (bottom) - $2 \frac{13}{16}$ " (71.4 mm)
4. Loosen bolt underneath sensor to adjust up or down if out of position.
Bolt needs to be fairly tight to not move.

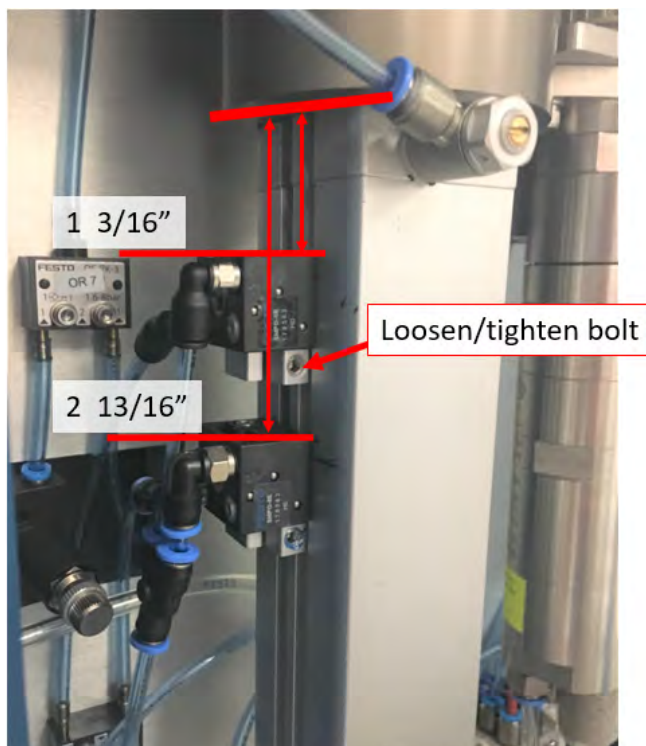
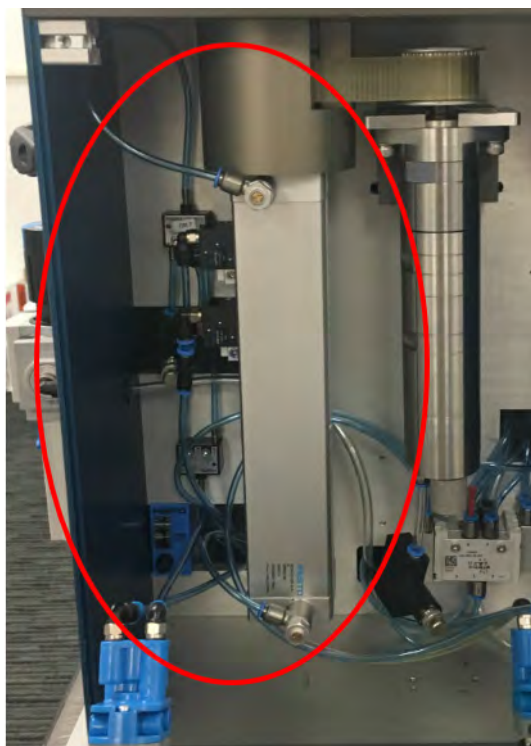

13. Appendix

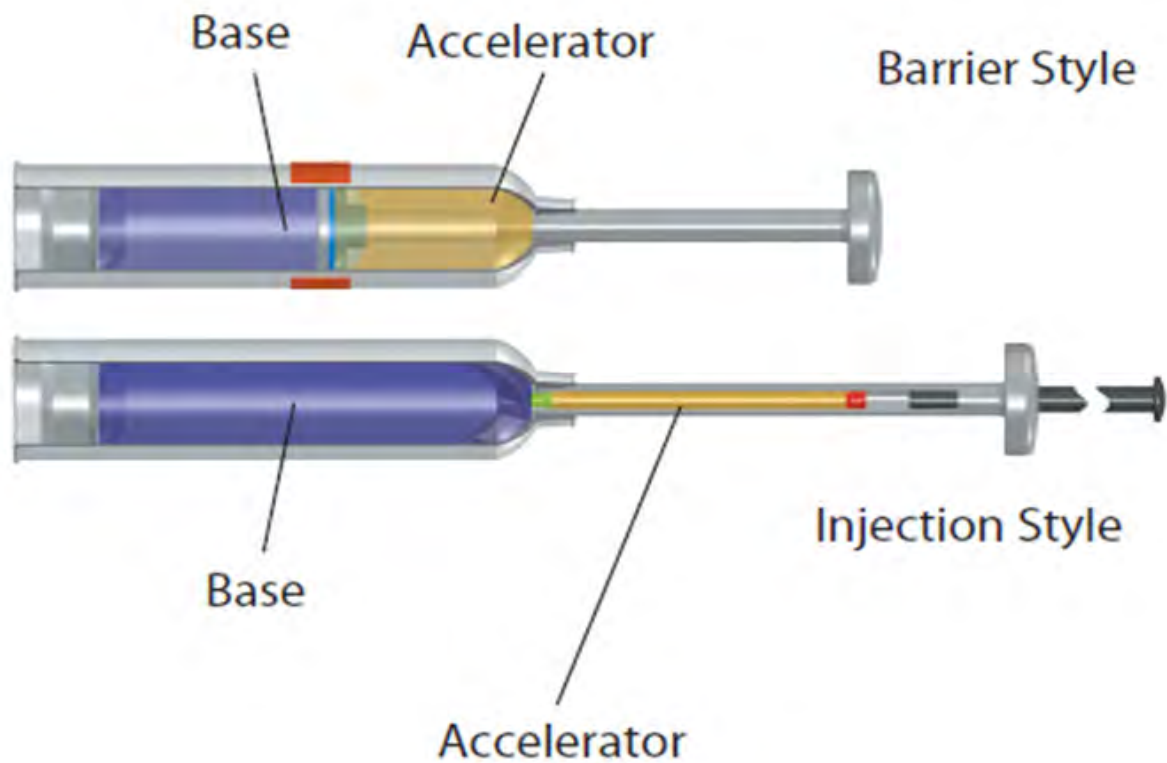

14. Schematic

Semco® 1088 CE Mixer Pneumatic Diagram

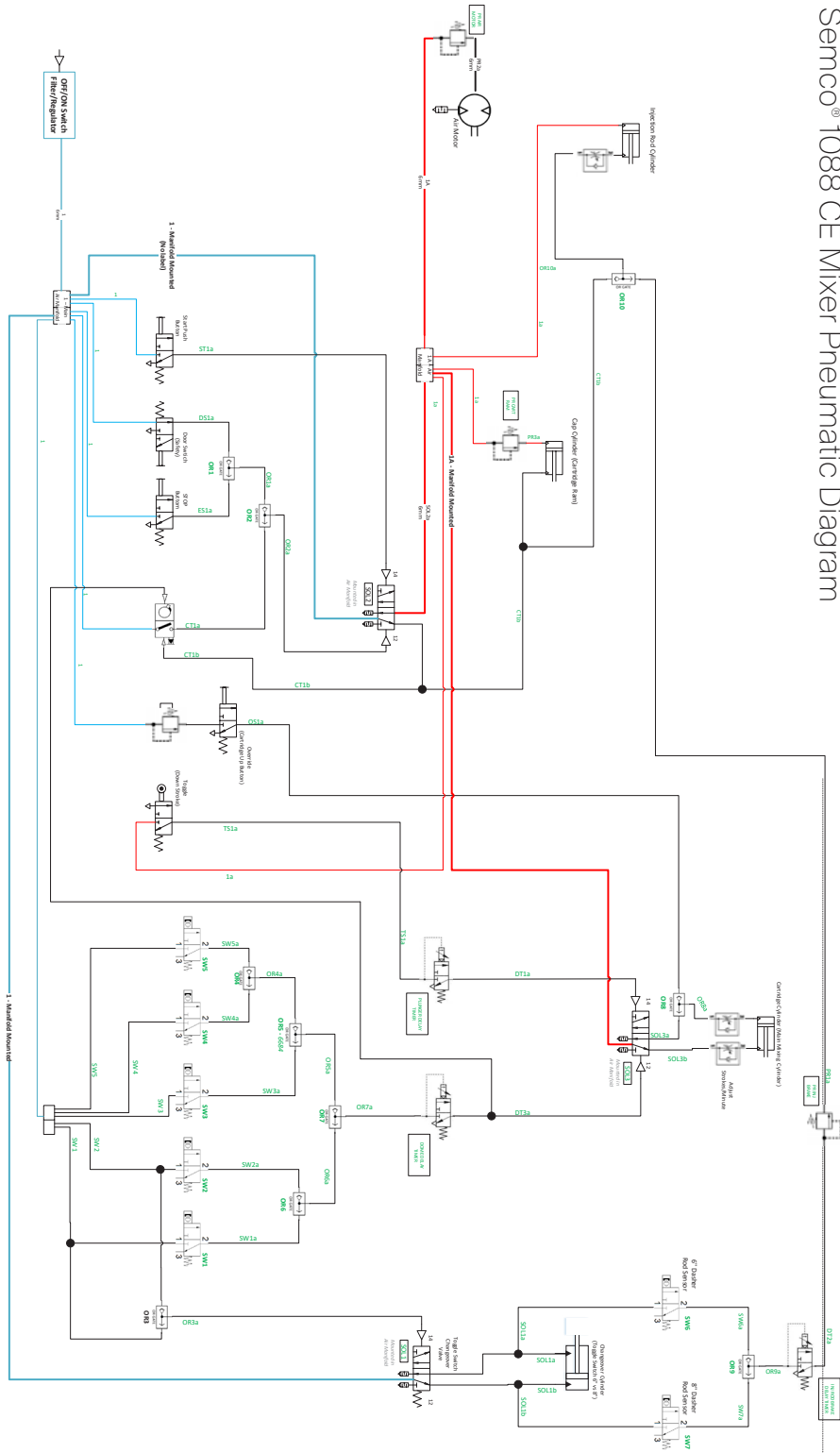

Semco®
Packaging and Application Systems
www.semcopackaging.com
Email: semcoinfo@ppg.com

For the Application Support Center nearest you, please visit our website at www.semcopackaging.com

All recommendations, statements, and technical data contained herein are based on test we believe to be reliable and correct, but accuracy and completeness of said tests are not guaranteed and are not to be construed as a warranty, either expressed or implied. User shall rely on his own information and tests to determine suitability of the product for the intended use and assumes all risks and liability resulting from his use of the product. Seller's and manufacturer's sole responsibility shall be to replace that portion of the product of this manufacturer which proves to be defective. Neither seller nor manufacturer shall be liable to the buyer or any third person for injury, loss, or damage directly or indirectly resulting from use of, or inability to use, the product. Recommendations or statements other than those contained in a written agreement signed by an officer of the manufacturer shall not be binding upon the manufacturer or seller.

Semco and Semkit are trademarks of PRC-DeSoto International, Inc.

Version uploaded 05/11/2019

PRC-DeSoto International, Inc.
12780 San Fernando Road
Sylmar, CA 91342
T: +1 (818) 362-6711
Toll Free: +1 (800) AEROMIX
www.ppgaerospace.com

Issue Date: 6/18
Supersedes: New
Lit: 4606

Polymer Systems *PST* Technology Limited

Silicone Sales & Services UK - Ireland - Benelux

© 2019 - Polymer Systems Technology Limited™
Unit 2. Network 4. Cressex Business Park,
Lincoln Road, High Wycombe, Bucks. HP12 3RF

tel: +44 (0) 1494 446610

web: <https://www.silicone-polymers.com>

email: sales@silicone-polymers.co.uk

